

Qty: 4  
 wall mounting brackets per banner attached to stone wall with self-tapping lag and shield bolts  
 Each mounting bracket will be compatible with:  
 1- plates to use with grommet-mounted banners or  
 2- poles to use with pole-mounted banners

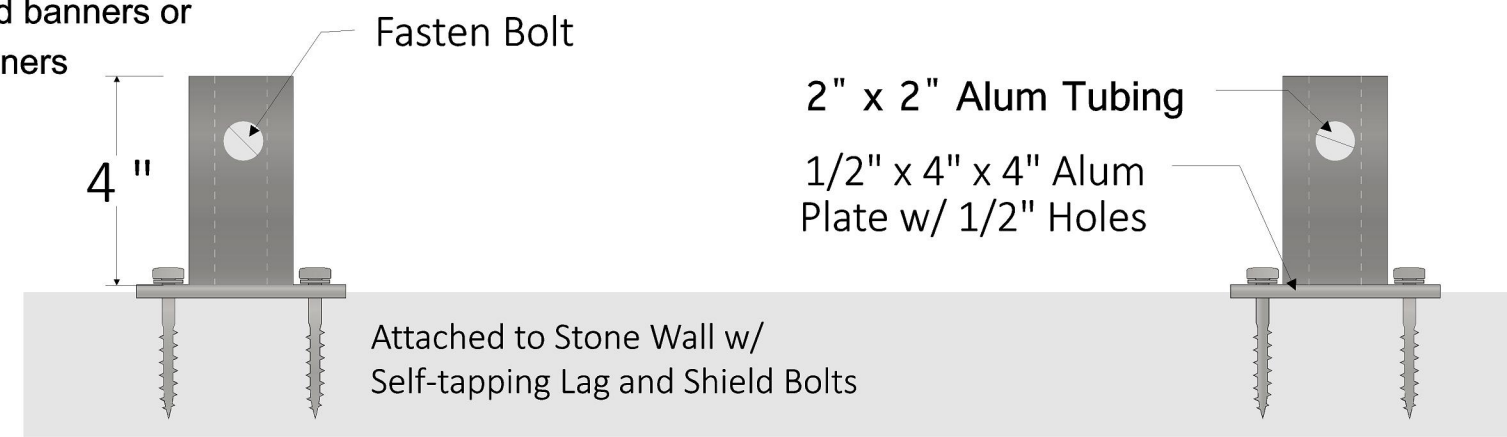

To use with banners with Grommets

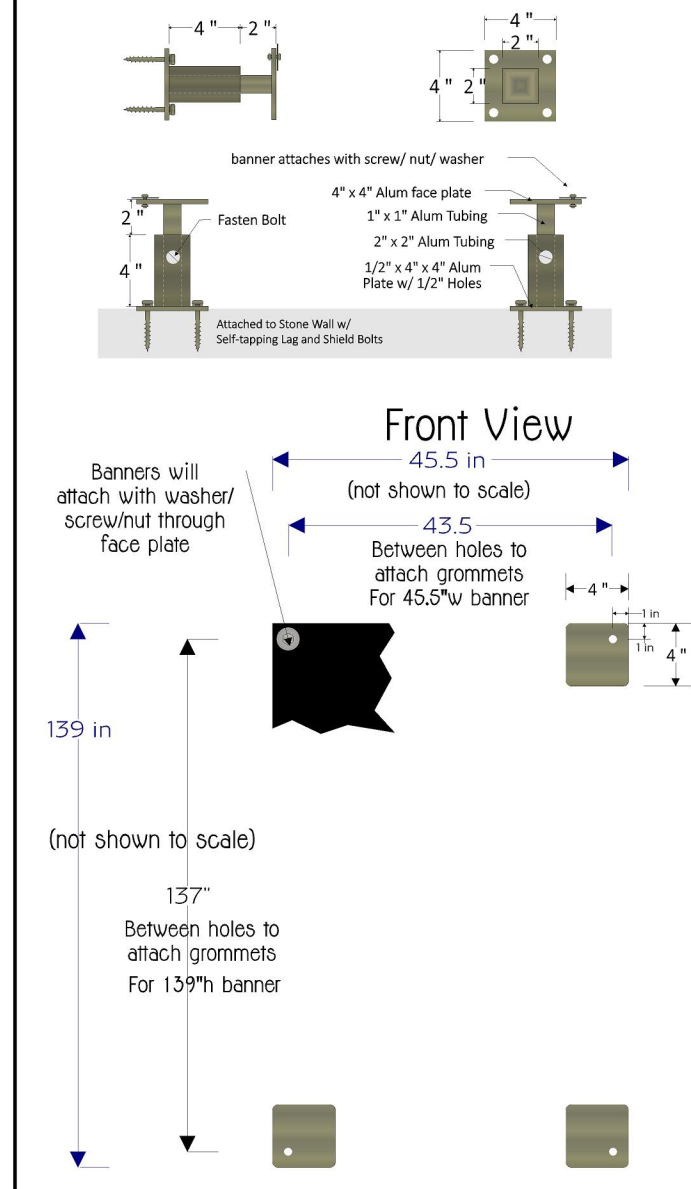

To use with banners with Pole Pockets

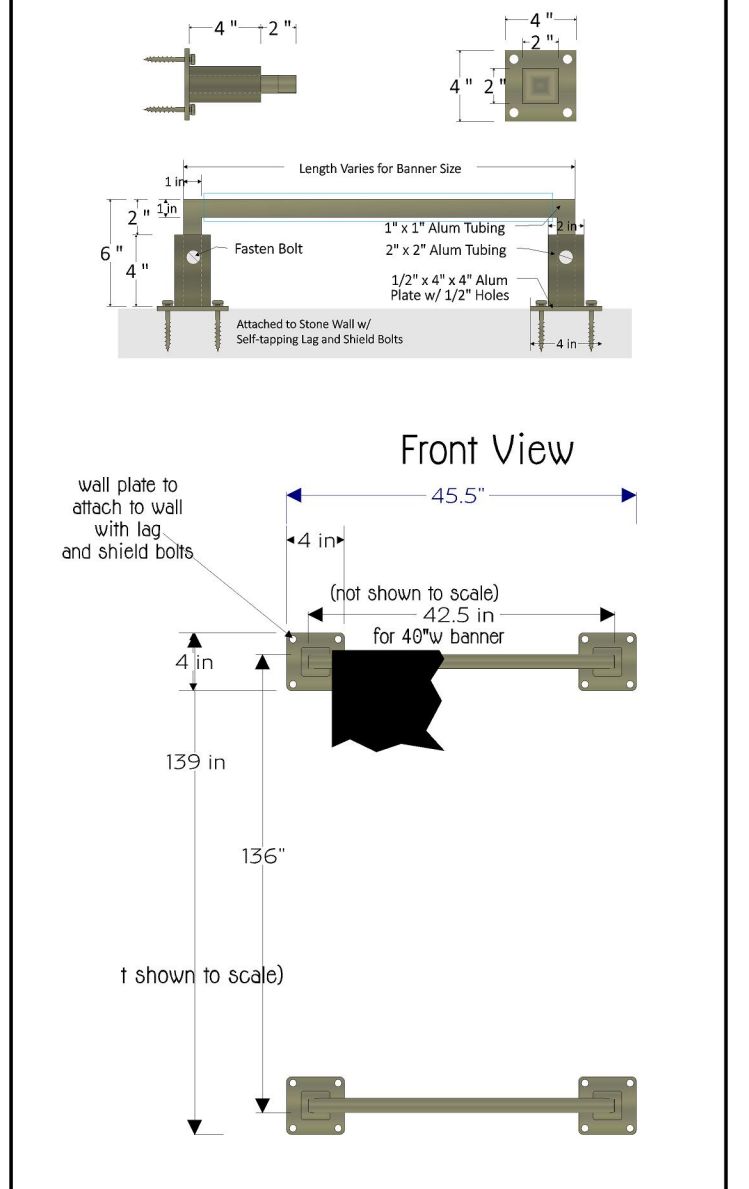

# Locust Street (near Mozart PI)

## Banners with Grommets

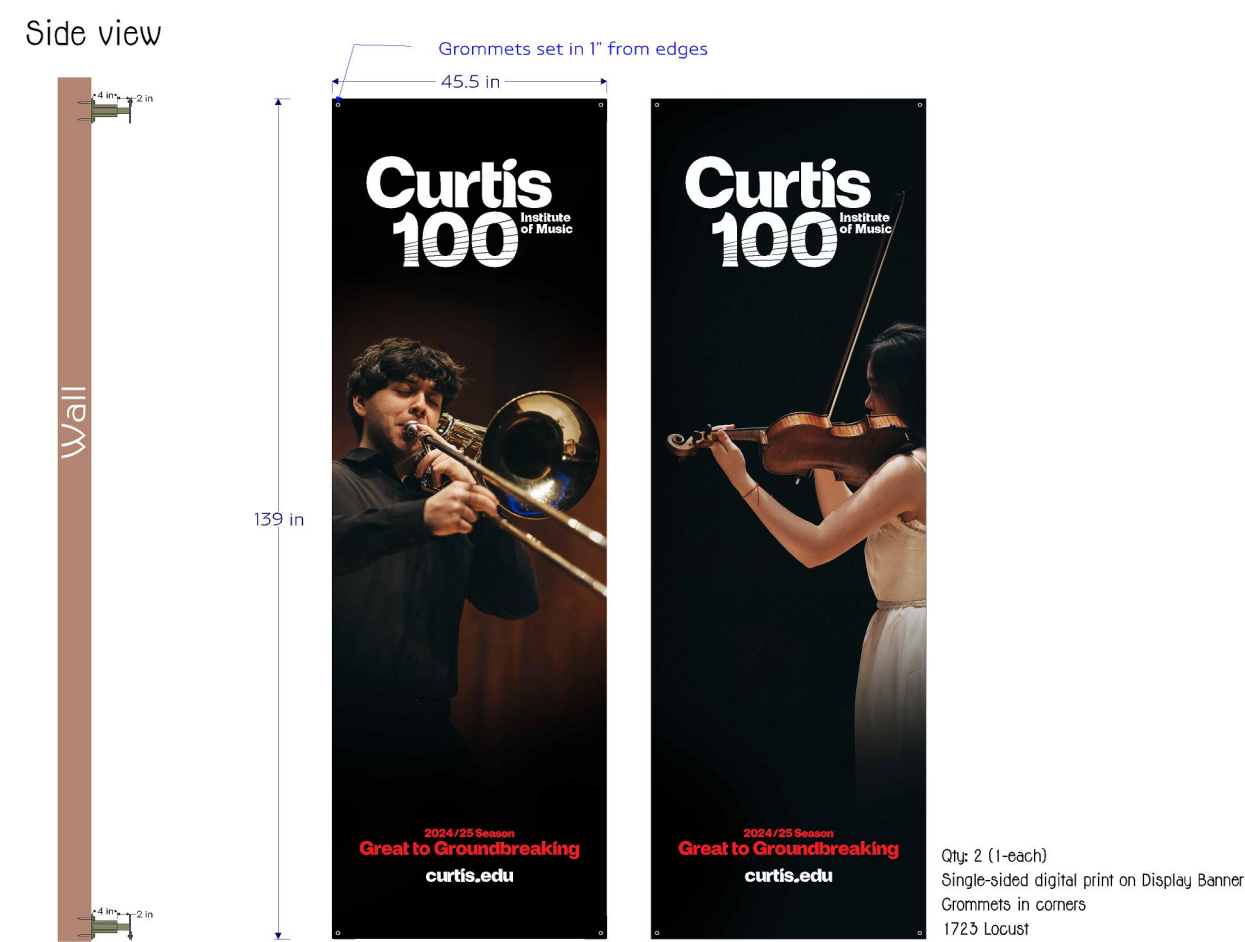

## Banners with Pole Pockets



Existing



Proposed

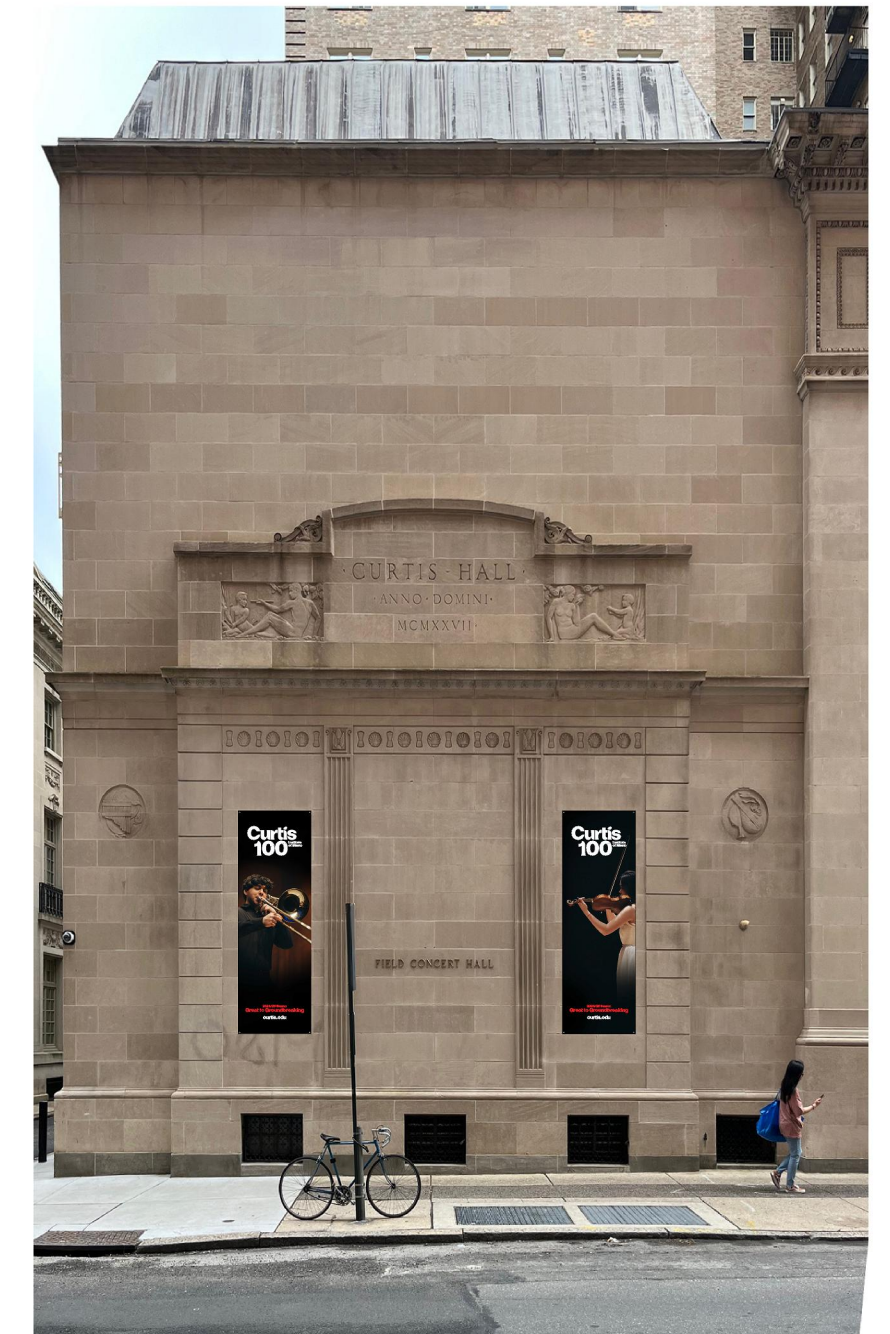



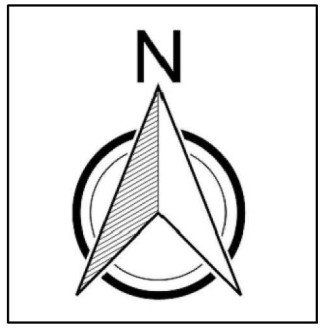

scale: 1" = 15'

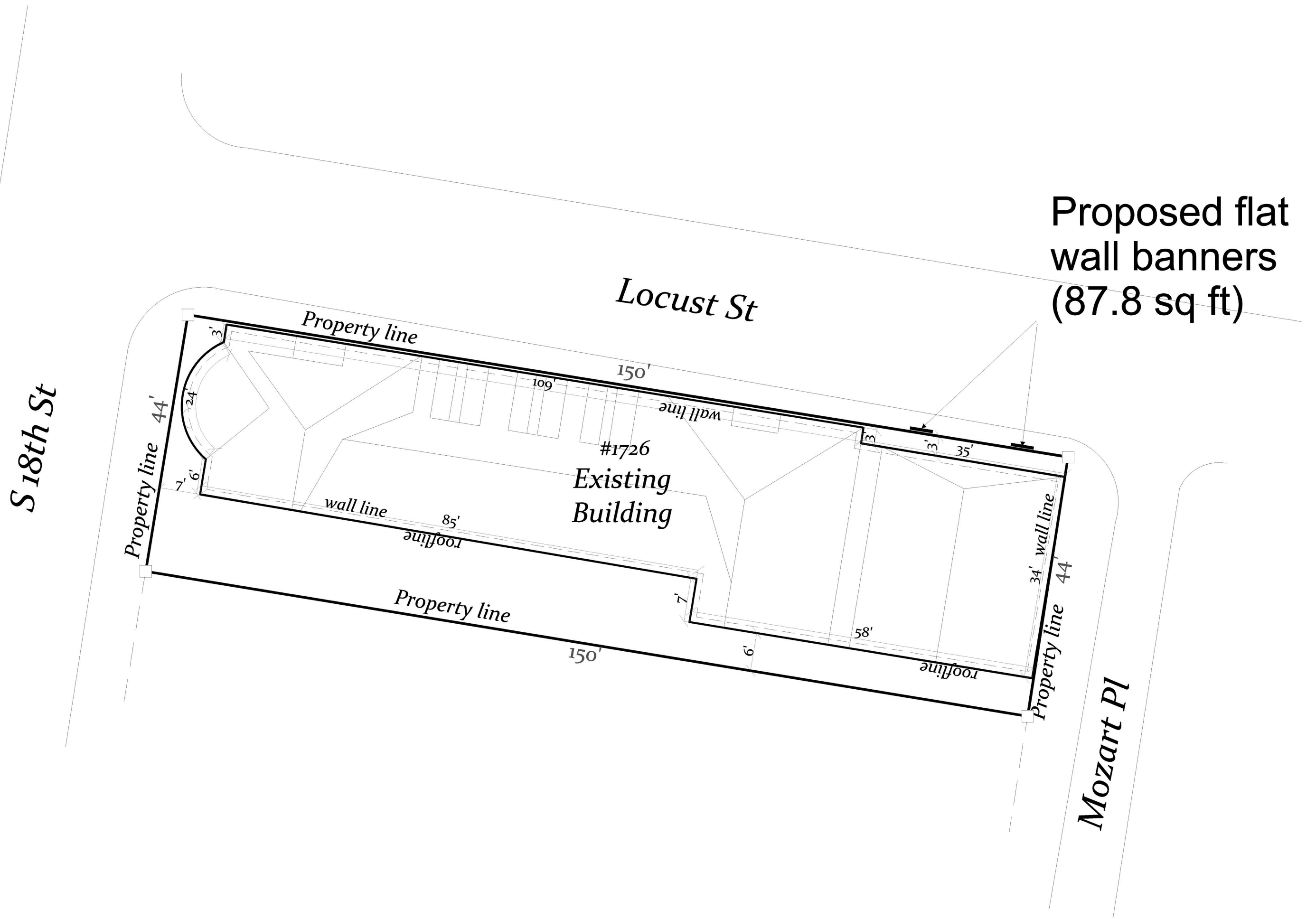

**Legend**

- Property line
- Topography line
- Wall line
- Roof line
- Retaining wall
- Fence
- Proposed addition