

NOTE:

- LOCATION AND SIZE OF ROOF OPENING AS WELL AS HEIGHT OF DORMER REMAINS AS ORIGINAL
- NOTE ORIGINAL FRAMING MEMBERS IN PHOTOS ABOVE

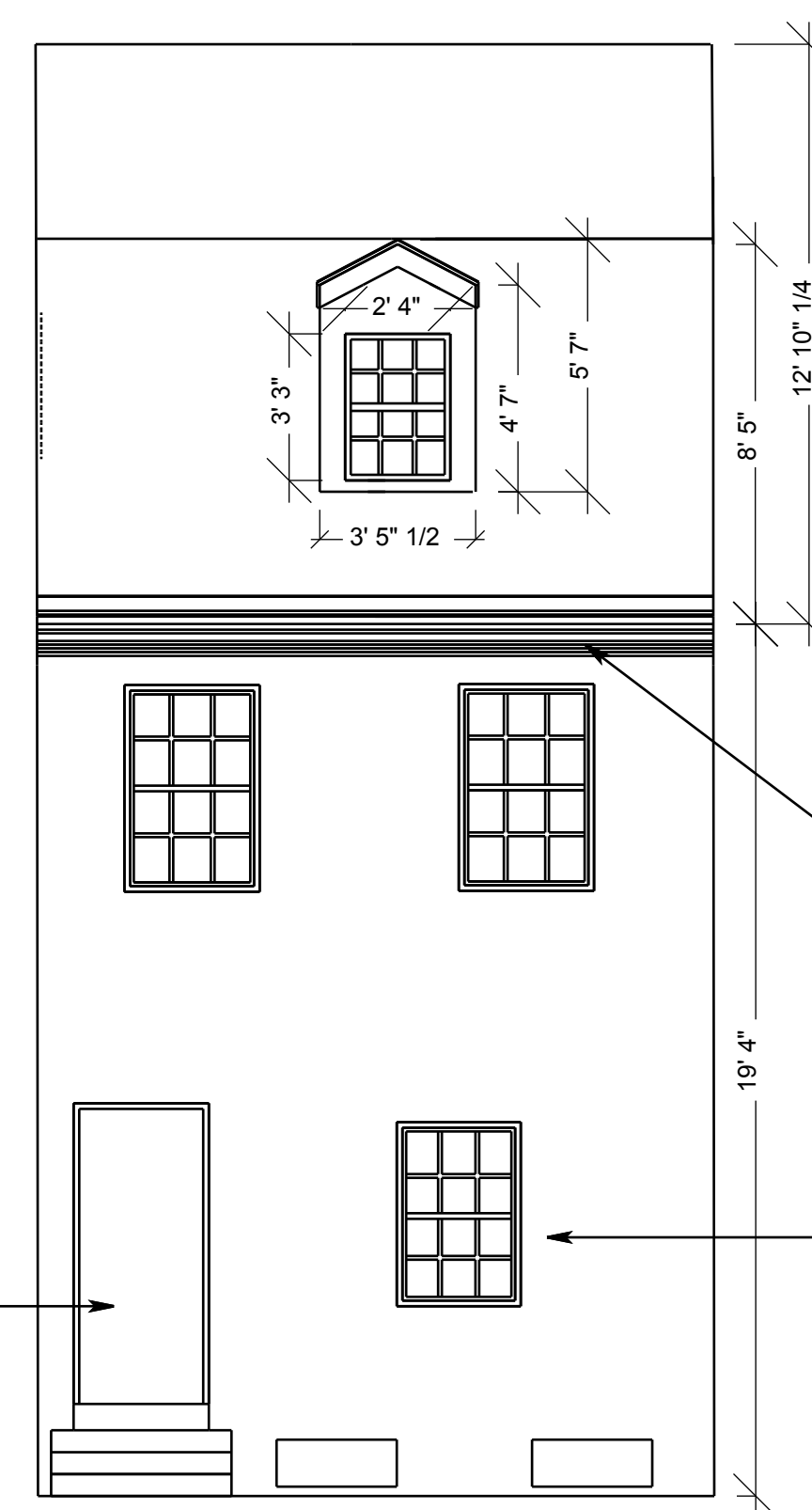

FRONT VIEW

LUMBER KORBEL PROFILE

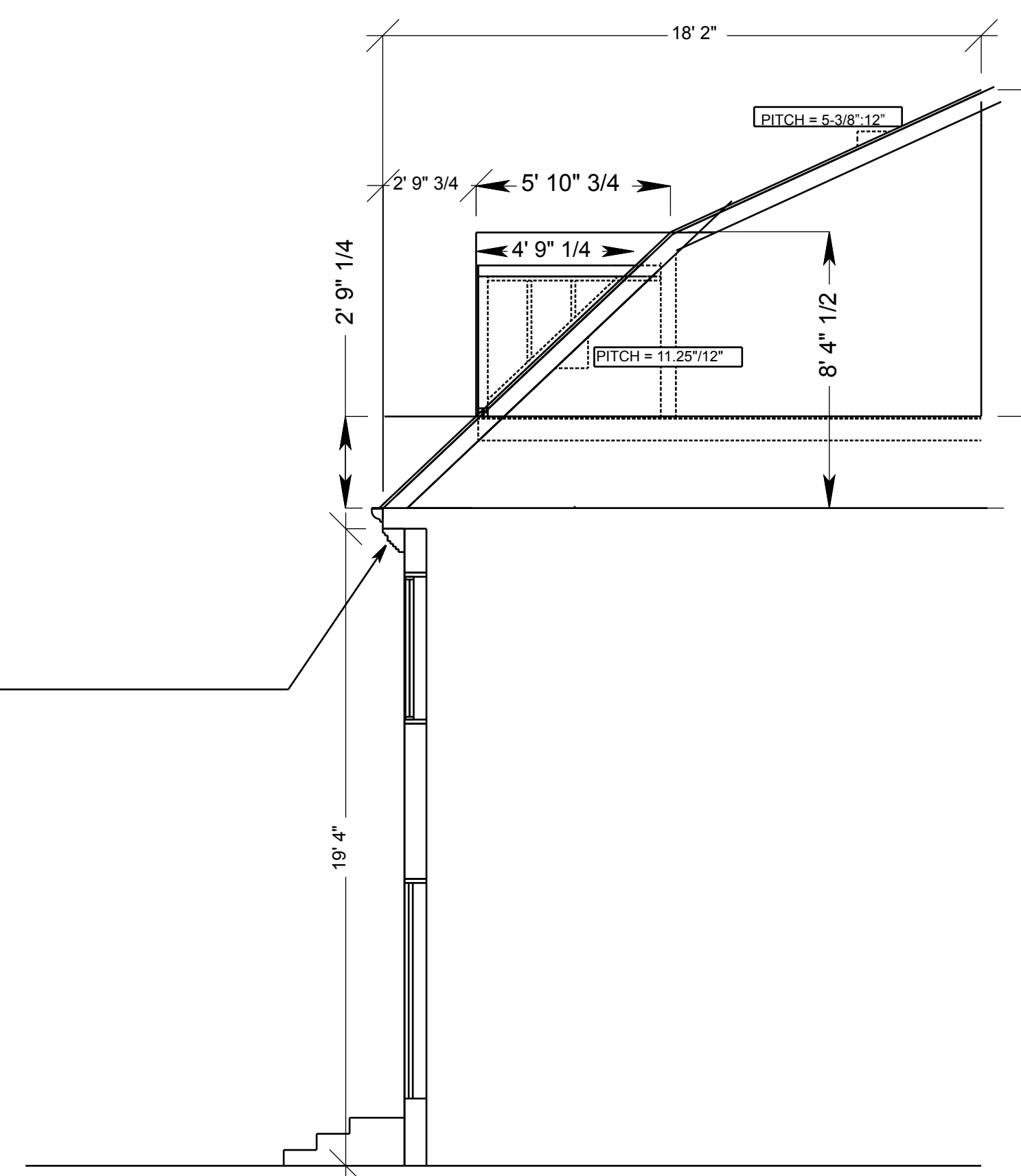

PROFILE VIEW

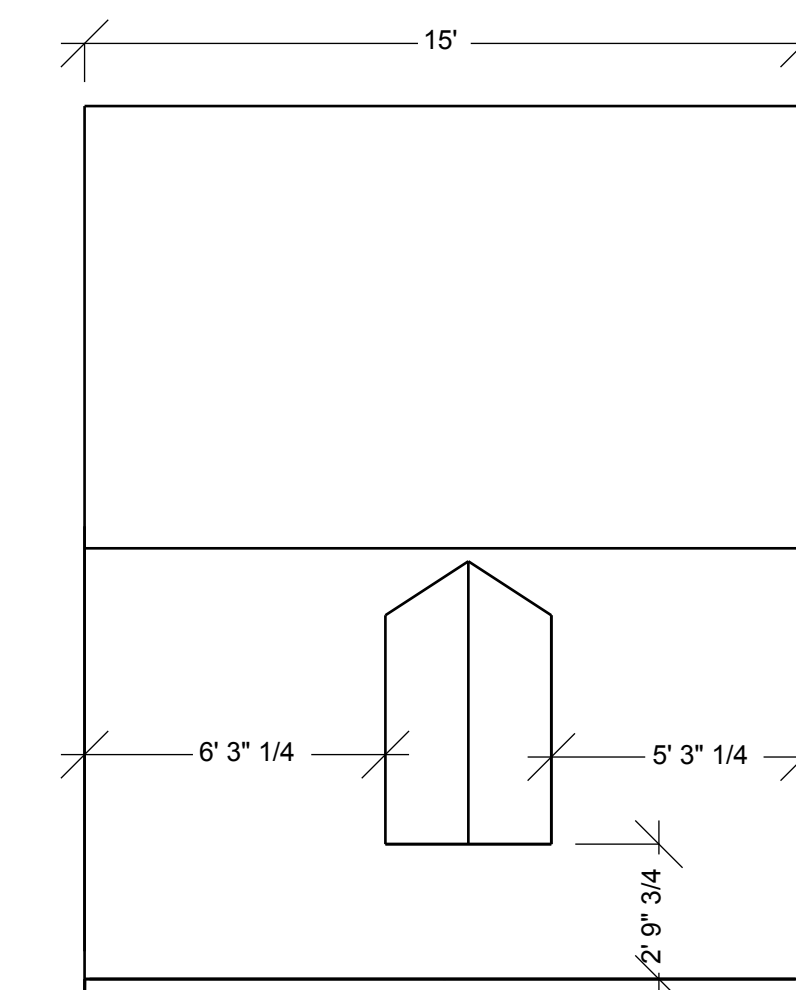

TOP VIEW

LUMBER CORNICE TO BE FABRICATED TO MATH THAT FOUND AT 1104 S FRONT STREET (1964)

6/6 SIMULATED DIVIDED LIGHT HIGH EFFICIENCY WOOD OR CLAD WOOD WINDOWS JELD-WEN SITELINE OR EQUIVALENT

6-PANEL FIBERGLASS EXTERIOR DOOR

HISTORIC COMMISSION PLANS

1108 S FRONT STREET
PHILADELPHIA, PA

OWNER

DML WORLDWIDE, LLC
11725 BRANDON ROAD
PHILADELPHIA, PA 19154

DATE: 18 NOV 2024
DRAWN: JB
SCALE: 1/4" = 1'

JAMES A. CLANCY, P.E.
601 ASBURY AVENUE
NATIONAL PARK, NJ 08063
(P). 856.853.7306

SEAL:

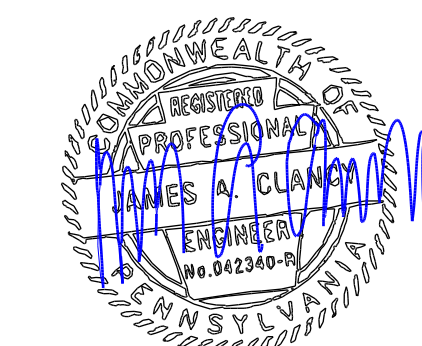

JELD-WEN®

SITELINE®
WOOD AND CLAD-WOOD
WINDOWS AND PATIO DOORS



ABOUT JELD-WEN

DEDICATION FROM DAY ONE

Since 1960, when JELD-WEN began with one millwork plant, we've been dedicated to crafting windows and patio doors that enhance the beauty and functionality of your home. Today we continue that tradition with products that are durable and worry-free. It's the result of innovation as a driving force in all that we do.

It begins in the forests where we harvest our premium lumber. In addition to responsible reforestation practices, we reuse and recycle as much of our raw resources as possible. Innovation is also at the heart of our design and manufacturing process. With JELD-WEN, you can expect products that are more than just beautiful on the outside. The inner workings of our windows and doors are engineered to function for years to come.





TABLE OF CONTENTS

AURALAST® PINE	4
INTRODUCTION	6
ARCHITECTURAL STYLES	8
CHOOSING YOUR WINDOWS	16
Casement and Awning	17
Double-Hung	18
Pocket and Sash Pack	20
Specialty Shapes	22
CHOOSING YOUR PATIO DOORS	24
Sliding/Folding	27
Low-Friction Glider™	28
Multi-Slide	29
Swinging	30
Inswing with Hydrolock™ Technology	31
OPTIONS	
Patio Door Hardware	32
Window Hardware & Window Opening Control Devices	34
Color	36
Exterior Clad Trim & Divided Lites	40
Glass, Spacers, and Blink® Blinds	41
SPECIFICATIONS	
Product Detail Matrix	42
Warranty	45



 **AuraLast**[®]
REAL WOOD, REAL PROTECTION



AuraLast[®] pine is a patented wood product that provides protection against wood rot, water damage and termites. This water-based process fortifies wood all the way to the core, providing an exclusive level of protection you'll only find through JELD-WEN.

LIMITED
LIFETIME
WARRANTY
AURALAST[®] PINE

See page 45 for warranty information.



TRADITIONAL TREATMENT

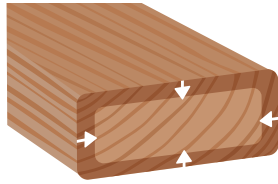

SURFACE ONLY

AuraLast®

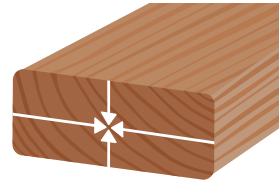

SURFACE TO CORE

Traditional treatments cover just the surface. AuraLast penetrates to the core using a proprietary vacuum-pressure process.



EASY ON THE ENVIRONMENT

Water-based process releases up to 96 percent fewer volatile organic compounds (VOCs) during the manufacturing process than traditional solvent-based methods.



WET WEATHER PROTECTION

Whatever the climate, AuraLast® pine protects against water damage and rot like no other. Whether it's humidity, storms or dampness, AuraLast® pine stands up to the rigors of wet weather.



TERMITE PROTECTION

Termites can be devastating to windows and doors, but not to those built with AuraLast® pine. It safely and effectively repels termites, preserving the beauty of your investment.

DETAILS THAT MAKE ALL THE DIFFERENCE

The result of more than a decade of research and development, JELD-WEN® Sitaline® windows and patio doors are designed to be more than beautiful. They are made to be reliable and efficient and are backed by a warranty that gives you peace of mind.

INNOVATION

Double-hung styles are designed with concealed jamb liners for a unique and uniform appearance. Casements feature recessed sash for heightened detail and energy efficiency.

PROTECTION

Built with superior AuraLast® pine protection against wood rot, water damage, and termites. See page 4 for more information.

VERSATILITY

Available with a wood or aluminum clad exterior, with extensive finish and hardware choices. Impact options available for most styles.

AUTHENTICITY

Able to meet most historical building requirements (please check your local regulations).

CONFIDENCE

Backed by a 20-Year Limited Warranty on each window or patio door, plus a Limited Lifetime Warranty on AuraLast® pine. See page 45 for more information.





VERSATILE DESIGN POSSIBILITIES

Siteline® windows and patio doors are designed and crafted to feel at home in any residential architectural style. See for yourself over the next few pages. Which style is closest to your vision for your home?

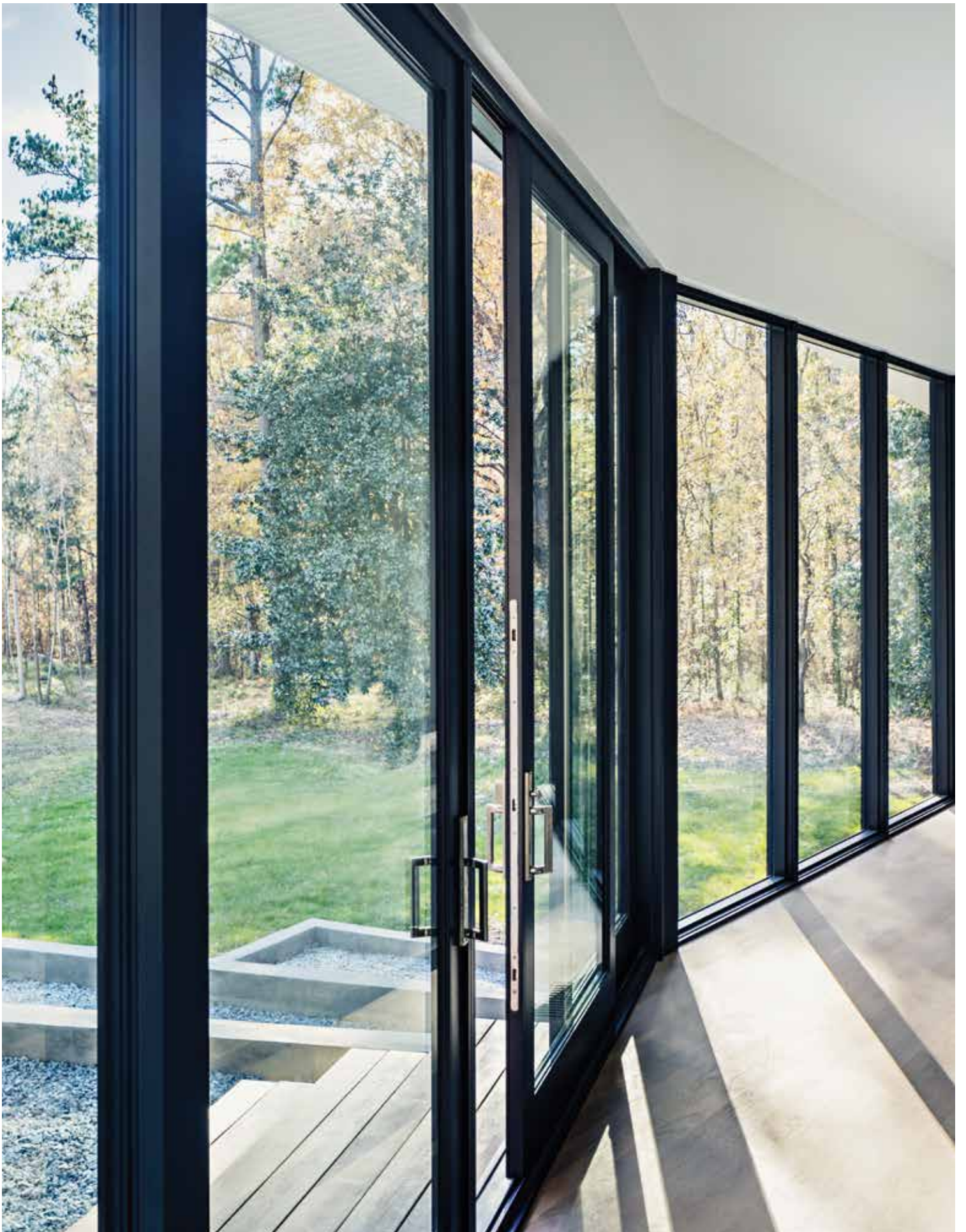



CONTEMPORARY

The simplicity, minimalism, and natural elements of contemporary architecture are elegantly embodied in Sitaline's clean, uniform look and feel.





TRANSITIONAL

Confidently blend and celebrate the best of traditional and modern elements with Sitaline's beautifully adaptable designs.





FARMHOUSE

Siteline's warm, natural beauty complements the comfort, ruggedness, and soul of timeless farmhouse design.

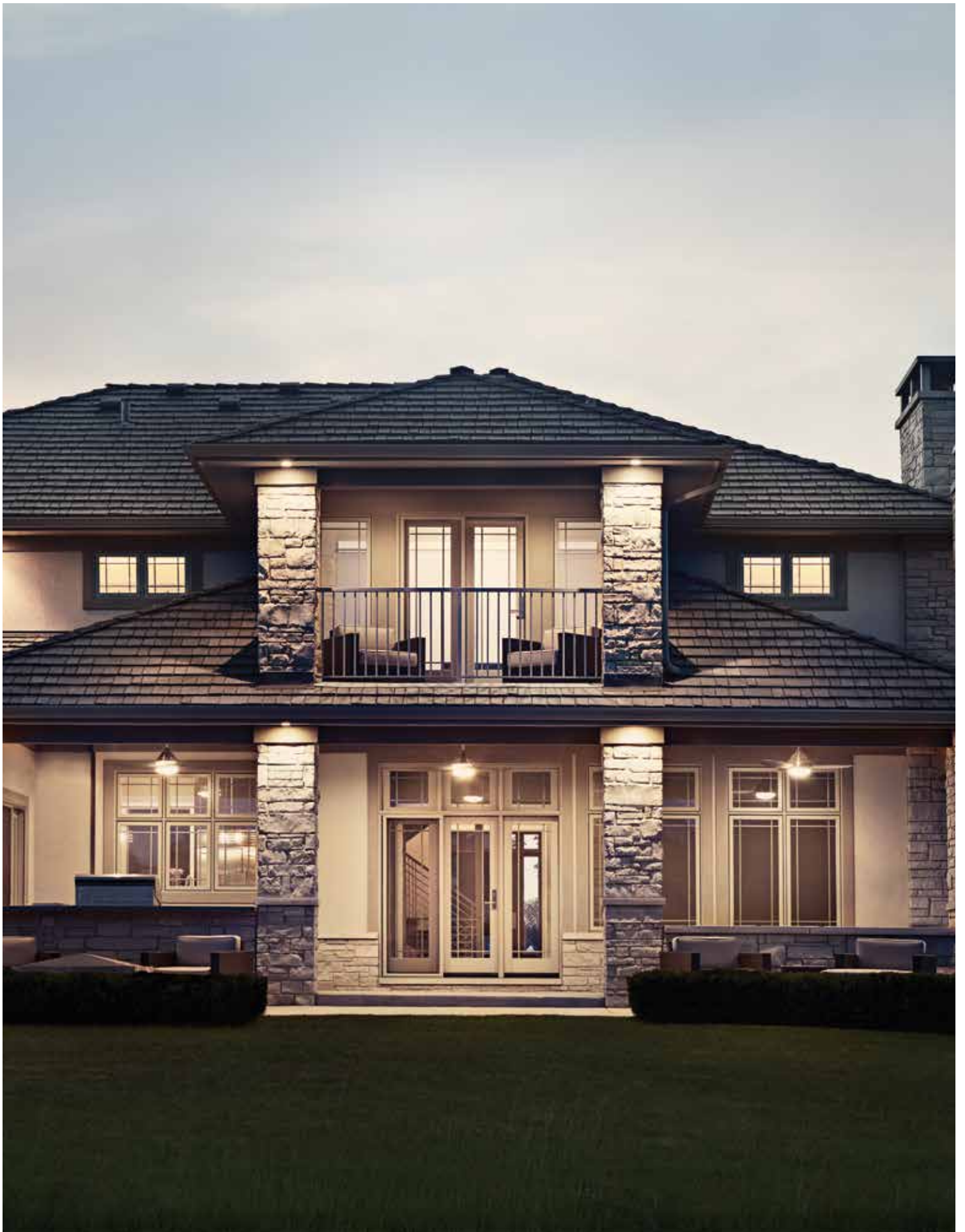



MODERN CRAFTSMAN

Experience the classic charm and fresh vitality of Modern Craftsman design with Sitaline's graceful authenticity.

CHOOSING YOUR WINDOWS

Consider placement and appearance, available space, and your preferences for views and ventilation. Whatever you're looking for, Sitaline® has a solution.





CASEMENT AND AWNING WINDOWS

Maximize ventilation and add a clean, modern accent to any room in the house.

AESTHETIC APPEAL

Both styles feature recessed sash for architectural interest and energy efficiency, plus a choice of traditional or contemporary glazing profiles.

PERFORMANCE

Siteline's design includes heavier hardware and greater thermal performance to help you achieve better efficiency.

PUSH-OUT OPTIONS

We also offer push-out styles that feature swinging screens and stylishly simple push-out handles.

DOUBLE-HUNG WINDOWS

State-of-the-art engineering meets traditional design,
with a variety of elegant options and innovative features.



BEAUTY

Concealed jamb liners create a uniform appearance that's unique to Sitaline®.



DESIGN CHOICES

Options include simulated divided lites (SDLs), sash configurations, and wood/clad variations (wood frame/ clad sash or clad frame/wood sash).

STRENGTH

Built with chambered composite interior sills for added strength and thermal efficiency.

CONVENIENCE

Simply slide in the tabs and tilt in both sash for easy, safe cleaning.

POCKET & SASH PACK WINDOWS

Bring superior quality, versatility, and heightened aesthetics to any residential construction project with Sitrine® Double-Hung Pocket, Casement Pocket, and Double-Hung Sash Pack windows. Each style is easy to install and includes quick connectors that conceal the jamb liners for a clean, uniform look.





SMALLER JAMB DEPTH

Siteline® replacement options offer wood or clad-wood windows with a jamb depth of 3 1/4".

AUTHENTICITY

Meets most historical building requirements (please check your local regulations).

EFFICIENCY

Upgrade any window with more energy-efficient, dual-pane sash options.





SPECIALTY SHAPES

FIXED, RADIUS, AND GEOMETRIC

Radius and geometric windows, available as fixed or operating units, add distinction and variety to any room in your house.

CHOOSING YOUR PATIO DOORS

With AuraLast® pine or cladding outside, Sitaline® patio doors provide multiple color and style selections with solid craftsmanship and durability built in.









SLIDING PATIO DOORS

Simple, elegant, and built to last, these doors slide along horizontal tracks that don't take up any additional floor space.

CONSISTENCY

Choose wide or narrow stile designs to match your windows and complement your architectural style.

ALSO IN FOLDING

Siteline® folding patio doors are also available.

See page 44 for more information.



LOW-FRICTION GLIDER™

The first product of its kind to deliver the benefits of a wall system at a price comparable to that of a sliding door.

SIZE

Configurations of 1-4 panels, each as large as 7' wide and 10' tall, maximize natural light and panoramic views.

EASE

Innovative rollers let active panels shift outward and glide effortlessly, then draw back toward the frame for a superior seal.

PERFORMANCE

Robust design earns performance ratings up to PG50, depending on panel size and configuration.

MULTI-SLIDE

This unique luxury offering creates openings up to 57' wide, filling the home with natural light and blurring the line between indoor and outdoor living space.

OPTIONS

Panels up to 5' wide and 9' tall, with stacking or pocketing configurations; up to six panels in a single direction, or 12 panels parting from the middle.

OPERATION

Acetal wheels deliver smooth, quiet operation, even with extreme panel weights.

APPEARANCE

Narrow 3" stiles and rails provide more glass, more natural light, and better views.





SWINGING PATIO DOORS

Create an impressive, sophisticated entrance with swinging patio doors available in a variety of configurations, including French doors.

CHOICE

Available with one to four panels that swing out or in on side hinges.

PERFORMANCE

The energy-efficient fiberglass sill allows water to drain away while preventing high winds and rain from coming in.

ACCESS

Inswing and outswing patio doors are available with an optional ADA-compliant sill for wheelchair accessibility.

IN SWING PATIO DOOR WITH HYDROLOCK™ TECHNOLOGY

Featuring a redesigned sill with Hydrolock™ technology, these doors deliver robust water management that matches or surpasses industry-leading performance ratings.

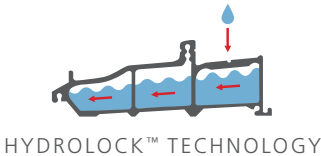

INNOVATION

Patent-pending fiberglass sill and corner key design continually moves water away from the home.

RATINGS

PG45 rating on 1- and 2-panel systems up to 36" panel width; PG35 rating on 1- and 2-panel systems greater than 36" panel width and 3- and 4-panel systems.





AVERDENE™

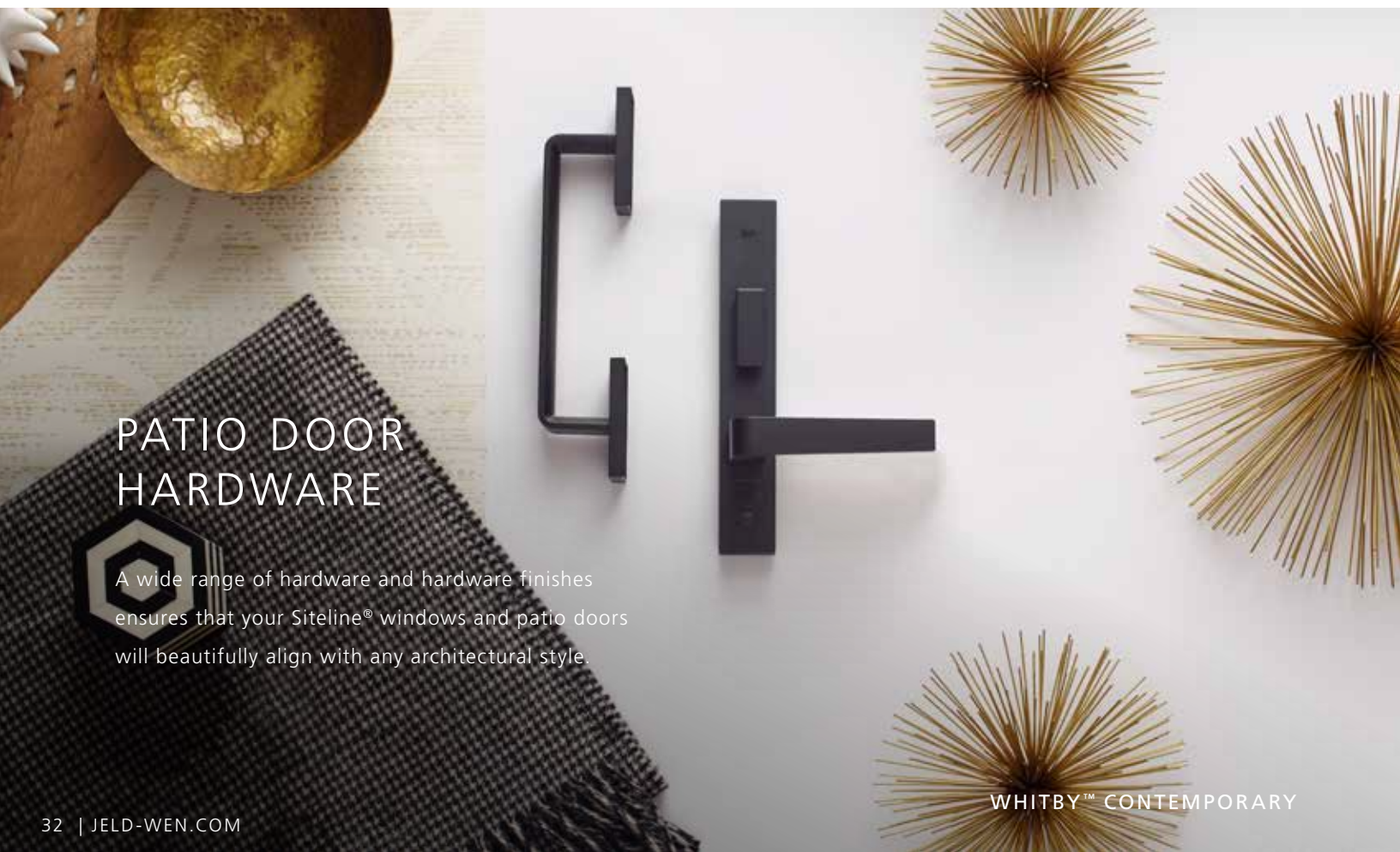

PATIO DOOR HARDWARE











A wide range of hardware and hardware finishes ensures that your Sitaline® windows and patio doors will beautifully align with any architectural style.

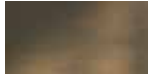

BELMAR™ TRANSITIONAL

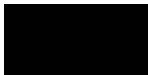

HARLESTON™ TRADITIONAL

	
White	Polished Chrome*
	
Polished Brass*	Satin Brass*
	
Antique Brass*	Satin Nickel*
	
Oil-Rubbed Bronze**	Chestnut Bronze
	
Matte Black	Black Chrome*

Finishes will perform at or above PVD-tested finishes.

*Plated finish

**Finish will not change over time

Actual colors may vary from samples shown due to printing process and/or differing monitor calibrations.



WINDOW HARDWARE

WINDOW HARDWARE OPTIONS

CASEMENT AND AWNING	DOUBLE-HUNG AND HORIZONTAL SLIDING
<p>STANDARD FOLDED NESTING HANDLE</p> 	<p>CONCEALED SASH LOCK</p> 
<p>PUSH-OUT HANDLE</p> 	

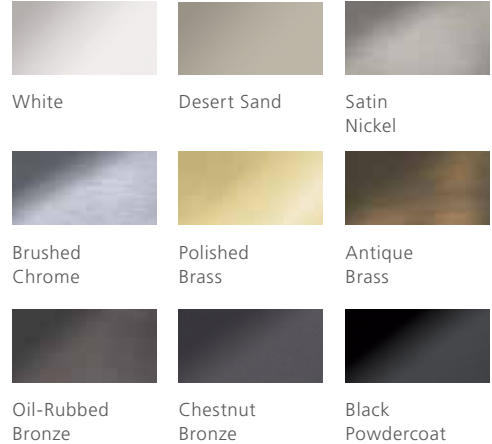

Actual colors may vary from samples shown to due printing process and/or differing monitor calibrations.

WINDOW OPENING CONTROL DEVICES (WOCD)

AVAILABLE ON DOUBLE-HUNG AND CASEMENT WINDOWS

Because windows can be necessary for emergency escape and rescue, building codes in your area may require certain windows to open fully. Factory-installed window opening control devices are designed to meet the current ASTM F2090 standard intended to help prevent accidental falls from windows by children five years of age and younger. A WOCD automatically limits the sash opening to less than four inches, unless it is deliberately disengaged, allowing the sash to open fully.



Window Open

Window Closed



COLOR

Personalize your wood or aluminum clad windows and patio doors with 27 exterior finishes and 16 interior finishes. Custom colors and PVDF protection are also available.

BRILLIANT WHITE



ROSEMARY

INTERIOR PAINTS



INTERIOR STAINS

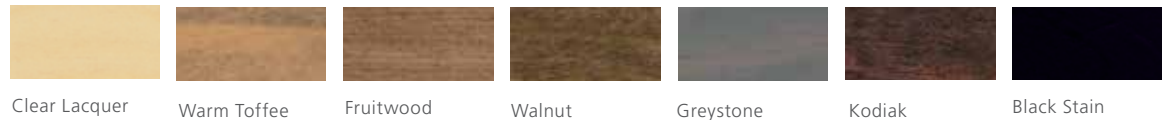









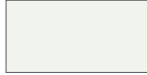

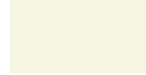
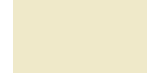
Actual colors may vary from samples shown due to printing process and/or differing monitor calibrations.





MOSS

EXTERIOR CLADDING COLORS

						
Bone White	Brilliant White	Ivory	French Vanilla	Heirloom White	Mocha Cream	Desert Sand
						
Silver	Smoke	Stone	Flagstone	Cocoa	Surf	



						
Sea Foam	Hunter Green	Moss	Hartford Green	Cranberry	Mesa Red	Stormy
						
Admiral	Navy	Steele Gray	Dark Chocolate	Chestnut Bronze	Luxury Bronze	Black

Actual colors may vary from samples shown due to printing process and/or differing monitor calibrations.

EXTERIOR CLAD TRIM

Select one of our exterior clad trim options to create the architectural look you want for your windows: historical, transitional, or contemporary.



Adams



3 1/2" Flat



Brickmould

OTHER OPTIONAL TRIM



2" Exterior Jamb Extension



Standard



1" Sill Nosing



2" Sill Nosing

DIVIDED LITES

Add architectural interest to your JELD-WEN® Sitrine® wood and clad-wood windows with one of our decorative grille options. These options include traditional or contemporary Simulated Divided Lites (SDL) for an authentic look, Full-Surround (FS) wood grilles that can be removed for easy cleaning, and maintenance-free Grilles Between the Glass (GBG).

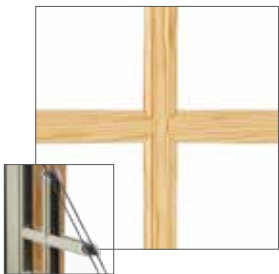

Simulated Divided Lites (SDL)

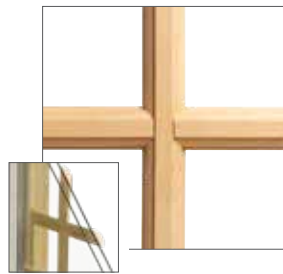

Full-Surround (FS) Wood Grilles



Grilles Between the Glass (GBG)



Contemporary Simulated Divided Lites (SDL)

GLASS

LOW-E INSULATING GLASS

Our standard high-performance Low-E insulating glass enhances energy conservation by helping homes stay cooler in the summer and warmer in the winter. Low-E glass provides greater protection against solar heat gain, reduces condensation, and helps limit fading of interior furnishings. Additional Low-E glass options are available for improved thermal performance

DIRT-RESISTANT GLASS

Standard for all Sitaline® products, this innovative product harnesses the sun's UV rays to loosen dirt from the glass, so that rainwater can easily rinse away any grime. No manual activation is required.

PROTECTIVE FILM

Standard for all Sitaline® products, this film is factory-applied to both sides of the glass. It protects against debris and scratches during shipping and handling or at a construction site. Easy to remove, it saves clean-up time after installation.

TEMPERED GLASS

Treated with heat in order to withstand greater force or pressure on its surface, tempered glass will not break into sharp pieces. It is used most frequently on patio doors or windows installed near floor level.

ENERGY STAR® OPTIONS

Many JELD-WEN® windows and doors are ENERGY STAR certified, which means they exceed the minimum energy efficiency criteria for the climate region in which you live. JELD-WEN has been a proud ENERGY STAR partner since 1998. Please see your local dealer for options in your area.

SPACERS

STANDARD

For even more versatility, spacer bar color options enhance the appearance of your windows.



BLINDS BETWEEN GLASS

Select Sitaline® windows and patio doors are available with Blink® Blinds + Glass. This exceptional blinds-between-the-glass offering delivers a clean, modern design with a choice of six colors, plus performance glass options. Blink blinds never need dusting, and there are no exposed cords.



PRODUCT DETAIL MATRIX

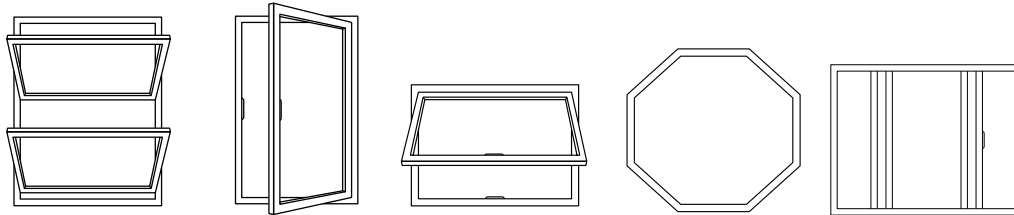

	Double-Hung	Casement	Awning	Geometric	Sliding
Hardware	Sash lock with integrated tilt latches	Nesting handle	Nesting handle	N/A	Sash lock
Hardware Finishes	9 Finishes	9 Finishes	9 Finishes	9 Finishes	9 Finishes
Glass Options	50+ Choices	50+ Choices	50+ Choices	50+ Choices	50+ Choices
Sizes: Min Max	21 3/8" x 32" 45 3/8" x 92"	18" x 18" 36" x 84"	18" x 18" 60" x 48"	18" x 18" 108" x 78"	29" x 23" 72" x 60"
Grilles	GBG: 5/8" Flat, 23/32" Contoured, 1" Contoured Bead: 7/8", 1 1/8", 1 3/8", 2 5/16" Putty: 5/8", 7/8", 1 1/8", 1 3/8", 2 5/16" Contemporary: 5/8", 7/8", 1 1/8", 1 3/8", 2 5/16" Combination SDL available: mix and match designs	GBG: 5/8" Flat, 23/32" Contoured, 1" Contoured Bead: 7/8", 1 1/8", 1 3/8", 2 5/16" Putty: 5/8", 7/8", 1 1/8", 1 3/8", 2 5/16" Contemporary: 5/8", 7/8", 1 1/8", 1 3/8", 2 5/16" Combination SDL available: mix and match designs	GBG: 5/8" Flat, 23/32" Contoured, 1" Contoured Bead: 7/8", 1 1/8", 1 3/8", 2 5/16" Putty: 5/8", 7/8", 1 1/8", 1 3/8", 2 5/16" Contemporary: 5/8", 7/8", 1 1/8", 1 3/8", 2 5/16" Combination SDL available: mix and match designs	GBG: 5/8" Flat, 23/32" Contoured, 1" Contoured Bead: 7/8", 1 1/8", 1 3/8", 2 5/16" Putty: 5/8", 7/8", 1 1/8", 1 1/8", 1 3/8", 2 5/16" Contemporary: 5/8", 7/8", 1 1/8", 1 3/8", 2 5/16" Combination SDL available: mix and match designs	GBG: 5/8" Flat, 23/32" Contoured, 1" Contoured Bead: 7/8", 1 1/8", 1 3/8", 2 5/16" Putty: 5/8", 7/8", 1 1/8", 1 3/8", 2 5/16" Contemporary: 5/8", 7/8", 1 1/8", 1 3/8", 2 5/16" Combination SDL available: mix and match designs
Performance Rating	45 3/8" x 80" - PG 50, WZ3 - PG +50/-65	36" x 72" - PG 50, WZ3 - PG +50/-65	48" x 48" - PG 50, WZ3 - PG +50/-65	84" x 84" - PG 50, WZ3 - PG +50/-65	72" x 60" - PG30
Configurations	Special Mulls, Transoms, Bays & Bows, Multiples	Special Mulls, Transoms, Bays & Bows, Multiples	Special Mulls, Transoms, Multiples	Special Mulls, Multiples	N/A
Spacer Color	Black (Standard), Gray & Silver	Black (Standard), Gray & Silver	Black (Standard), Gray & Silver	Black (Standard), Gray & Silver	Black (Standard), Gray & Silver
Blink® Blinds	N/A	White, Tan, Sand, Espresso, Silver Moon, Slate Gray	White, Tan, Sand, Espresso, Silver Moon, Slate Gray	White, Tan, Sand, Espresso, Silver Moon, Slate Gray	N/A

Other options available, including impact-rated options (depending on operating type) and screens.
For more information, please see your JELD-WEN representative or visit jeld-wen.com.

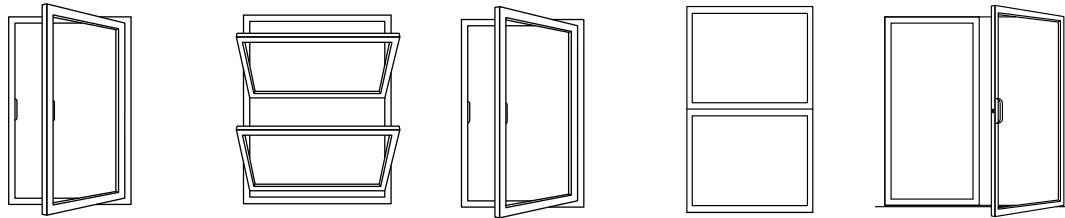

	Push-out Casement	Double-Hung Pocket	Casement Pocket	Sash Pack	Swinging Patio Doors
Hardware	Push-out handle	Sash lock with integrated tilt latches	Nesting handle	Sash lock with integrated tilt latches	Harleston™, Whitby™, Belmar™
Hardware Finishes	9 Finishes	9 Finishes	9 Finishes	9 Finishes	10 Finishes
Glass Options	50+ Choices	50+ Choices	50+ Choices	50+ Choices	50+ Choices
Sizes: Min	18" x 18"	21 3/8" x 31 7/32"	18" x 18"	20" x 30"	23 5/8" x 79 1/2"
Max	36" x 72"	45 3/8" x 92"	36" x 72"	40" x 90"	43" x 98 1/2" (Panel Size)
Grilles	GBG: 5/8" Flat, 23/32" Contoured, 1" Contoured Bead: 7/8", 1 1/8", 1 3/8", 2 5/16" Putty: 5/8", 7/8", 1 1/8", 1 3/8", 2 5/16" Contemporary: 5/8", 7/8", 1 1/8", 1 3/8", 2 5/16" Combination SDL available: mix and match designs	GBG: 5/8" Flat, 23/32" Contoured, 1" Contoured Bead: 7/8", 1 1/8", 1 3/8", 2 5/16" Putty: 5/8", 7/8", 1 1/8", 1 3/8", 2 5/16" Contemporary: 5/8", 7/8", 1 1/8", 1 3/8", 2 5/16" Combination SDL available: mix and match designs	GBG: 5/8" Flat, 23/32" Contoured, 1" Contoured Bead: 7/8", 1 1/8", 1 3/8", 2 5/16" Putty: 5/8", 7/8", 1 1/8", 1 3/8", 2 5/16" Contemporary: 5/8", 7/8", 1 1/8", 1 3/8", 2 5/16" Combination SDL available: mix and match designs	GBG: 5/8" Flat, 23/32" Contoured, 1" Contoured Bead: 7/8", 1 1/8", 1 3/8", 2 5/16" Putty: 5/8", 7/8", 1 1/8", 1 3/8", 2 5/16" Contemporary: 5/8", 7/8", 1 1/8", 1 3/8", 2 5/16" Combination SDL available: mix and match designs	GBG: 5/8" Flat, 23/32" Contoured, 1" Contoured Bead: 7/8", 1 1/8", 1 3/8", 2 5/16" Putty: 5/8", 7/8", 1 1/8", 1 3/8", 2 5/16" Contemporary: 5/8", 7/8", 1 1/8", 1 3/8", 2 5/16" Combination SDL available: mix and match designs
Performance Rating	36" x 72" - PG50	45" x 78" - PG50	36" x 72" - PG35	N/A	Inswing: PG35, PG50 Limited Water Outswing: PG50 WZ3 available
Configurations	Special Mulls, Transoms, Bays & Bows, Multiples	N/A	N/A	N/A	X, OX, XO, OXXO Sidelites & Transoms available
Spacer Color	Black (Standard), Gray & Silver	Black (Standard), Gray & Silver	Black (Standard), Gray & Silver	Black (Standard), Gray & Silver	Black (Standard), Gray & Silver
Blink® Blinds	N/A	N/A	N/A	N/A	N/A

PRODUCT DETAIL MATRIX

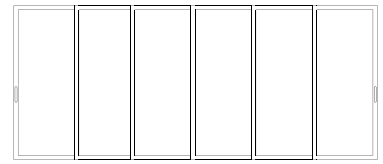
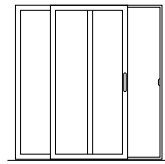
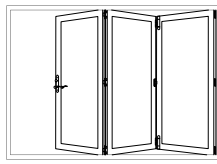
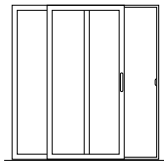

	Sliding Patio Doors	Folding Patio Doors	Low-Friction Glider™	Multi-Slide
Hardware	Harleston™, Whitby™, Belmar™, Averdene™	Standard	Flush Mount	Recessed
Hardware Finishes	10 Finishes	10 Finishes	3 Finishes	3 Finishes
Glass Options	50+ Choices	50+ Choices	4 Choices	Low-E
Sizes: Min	30" x 79"	62 1/2" x 80 3/8"	39" X 79 1/2" (1-Panel Size)	62 1/2" x 80 3/8"
Max	48" x 96" (Panel Size)	148" x 96" (Panel Size)	291 1/8" X 122 1/2" (4-Panel Size)	148" x 96" (Panel Size) Openings up to 57'
Grilles	GBG: 5/8" Flat, 23/32" Contoured, 1" Contoured Bead: 7/8", 1 1/8", 1 3/8", 2 5/16" Putty: 5/8", 7/8", 1 1/8", 1 3/8", 2 5/16" Contemporary: 5/8", 7/8", 1 1/8", 1 3/8", 2 5/16" Combination SDL available: mix and match designs	GBG: 5/8" Flat, 23/32" Contoured, 1" Contoured Bead: 7/8", 1 1/8", 1 3/8", 2 5/16" Putty: 5/8", 7/8", 1 1/8", 1 3/8", 2 5/16" Contemporary: 5/8", 7/8", 1 1/8", 1 3/8", 2 5/16" Combination SDL available: mix and match designs	Bead: 7/8" Putty: 7/8" Contemporary: 7/8"	Bead: 7/8" Putty: 5/8", 7/8"
Performance Rating	2-Panel Wide Stile - PG65 4-Panel Wide Stile - PG25 2-Panel Narrow Stiles - PG40 4-Panel Narrow Stiles - PG25	PG35 (Pending Configurations)	PG35 & PG50 (Pending Configuration & Sizing)	PG35 & PG50 (Pending Configuration & Sizing)
Configurations	OX, XO, OXXO Transoms Available	2-, 3-, or 4-Panel	Fixed, OX, XO, OOX, XOO, OXO, OXXO	6 panels in one direction or 12 panels in bi-parting direction w/ pocketing options
Spacer Color	Black (Standard), Gray & Silver	Black (Standard), Gray & Silver	Black, Gray, Silver	Black, Gray, Silver
Blink® Blinds	White, Tan, Sand, Espresso, Silver Moon, Slate Gray	N/A	N/A	N/A

JELD-WEN® WINDOW & PATIO DOOR LIMITED WARRANTY

OUR WARRANTY TO YOU...

JELD-WEN® Products¹ are designed to create lasting value for your home. This warranty is effective for all JELD-WEN window and patio door Products (except United Collection products) manufactured on or after **June 1, 2019** for use in the United States and Canada. Any previous warranties will continue to apply to products manufactured by JELD-WEN prior to this date. For additional information, including care and maintenance instructions, installation instructions, and previous warranties, refer to www.jeld-wen.com or www.jeld-wen.ca.

What This Warranty COVERS

Except as set forth in the Special Coverages section below, we warrant that if your JELD-WEN Product exhibits a defect in material or workmanship within the time periods from the date of manufacture as specified below, we will, at our option, repair, replace or refund the purchase price of the Product or component part. Skilled labor² (where deemed necessary by us) to repair or replace any component is provided as specified below.

	Wood & Metal Clad Wood	Composite	Vinyl and Metal Clad Vinyl	Aluminum
Basic Product Coverage Owner-Occupied Single-Family Residence	20 years	10 years; glass is covered for 20 years	as long as you own and occupy your residence	10 years
Basic Product Coverage Commercial (Other than Owner-Occupied Single-Family Residence)	20 years	10 years	10 years	2 years
Skilled Labor² Coverage	2 years	2 years	2 years	1 year
Transferability - the maximum length of any coverage when you sell your residence or it becomes occupied by other than the original owner	10 years	10 years	10 years	Non-transferable

Special Coverages (Applies to both Owner-Occupied and Commercial)

The following Special Coverages apply to special product features and options; not all options are available on all products or in all regions.

Glass Options	Coverage	Notes
Triple-Glazed Glass Units	20 years	Includes the glass panes and the insulating seal.
ImpactGard® Glass Units	10 years	
Special Glazings	5 years	Includes laminated glass units other than ImpactGard, and glass options not listed in our product literature, e.g., leaded or decorative glass.
Blinds/Shades Between the Glass	10 years	Includes the seal, external control mechanism, and operation of the shade/blind.
Stress Cracks	1 year	Applies to sealed glass units installed in windows and patio doors. Laminated glass and special glazings are excluded. Coverage includes replacement glass and skilled labor ² necessary to replace the glass. Stress cracks occur when the glass develops a crack without sign of impact.
Accidental Glass Breakage	Same as the Basic Product Coverage above (Owner-Occupied or Commercial)	Applies to Products ordered with double strength or thicker glass. Not covered: damage attributable to acts of nature (e.g. fire, hurricane, etc.), civil disorder, building settling, structural failures of walls or foundations or improper installation, construction job-site mishaps, storage, or handling. Special glazings and ImpactGard glass are not covered by this glass breakage warranty.
Finish Options	Coverage	Notes
Clad Finish on Metal Clad Exteriors	AAMA 2605: 30 years	Coverage is for peeling, checking, cracking, or exhibiting excessive chalk, fade or color change ³ . Clad products installed within one mile of a salt-water source (for example, an ocean or salt lake) or other corrosive environment require additional and specific maintenance requirements. Refer to our full care and maintenance instructions.
	AAMA 2603/2604: 10 years	
	Anodized: 5 years	
Factory Interior Finish on Wood Products	1 year	Coverage is for peeling, checking, or cracking. Should the factory interior finish be proven defective within this time period, we will at our option, replace or refinish the component or product, or offer a refinish credit up to \$50 per opening for windows or \$100 per opening for patio doors. This coverage applies to factory-applied finish coat options only; standard factory-applied primer is not a finish coat.
Colored and Laminated Surfaces on Vinyl and Composite Products	10 years	Coverage is for peeling, blistering, or flaking, and excessive color change ³ . This coverage does not extend to discoloration, polish, surface damage, or alteration caused by the use of natural or chemical solvents or an environmental factor causing such damage.

Continued on next page

Other Special Coverages	Coverage	Notes
AuraLast® Protection for Wood Products	Owner-Occupied Single-Family Residence: as long as you own and occupy your residence	Coverage is for wood decay and/or termite damage in pine wood components. Warranty coverage outside Canada, the contiguous 48 states and Alaska is contingent upon approval from the JELD-WEN Customer Care Department. Please contact us.
	Commercial: 20 years	
Custom Fiberglass Door Slabs	As long as you own and occupy your residence	
Factory Prefinish on Custom Fiberglass Doors	10 years	Should the factory prefinish be proven defective, we will at our option refinish the door or pay up to \$350.00 per opening to the current owner.
Electric Operators	1 year	Coverage includes replacement parts and skilled labor necessary to replace the operator for one year.
Retractable Roll Screens	5 years	

How To Get Assistance

If you have a problem with your JELD-WEN Product, contact the dealer/distributor or contractor from whom you purchased your product or contact us directly:

	In the United States:	In Eastern Canada:	In Western Canada:	In Ontario Canada
Mail:	JELD-WEN Customer Care Attn: Warranty Claims P.O. Box 1329 Klamath Falls, OR 97601	JELD-WEN Service Dept 90, rue Industrielle Saint-Apollinaire, Quebec Canada GOS 2E0	JELD-WEN Service Dept 550 Munroe Avenue Winnipeg, Manitoba Canada R2K 4H3	JELD-WEN Service Dept 90 Stone Ridge Road Vaughan, Ontario Canada L4H 3G9
Phone:	888-JWHelpU 888-594-3578	800-463-1930	888-945-5627 204-668-8230	800-440-2714 905-265-5700
Fax:	800-436-5954	888-998-1599	204-663-1072	905-265-5704
E-mail:	jeldwenwarranty@jeld-wen.com		wpgservice@jeld-wen.com	
Web:	www.jeld-wen.com/contact-us	www.jeld-wen.ca/contact-us		

We can respond quickly and efficiently if you provide the following: a) product identification (from the original order/invoice, spacer code, permanent label, or the window identification number found on corner of glass), b) how to contact you, c) the address where the product can be inspected, and d) a description of the apparent problem and the product (photographs are helpful).

What We Will Do

Upon receiving your notification, we will send out an acknowledgement within three business days to the contact, which you have provided. We will investigate your claim and will begin to take appropriate action within 30 days after receipt of notification. If your warranty claim is denied, we may charge an inspection fee for an onsite inspection that is required or requested by you.

If your claim is approved, and we choose to repair or replace the product or a component of the product, the replacement product/component will be provided in the same specification as the original product or its nearest equivalent current product. Replacement components/products are warranted for the balance of the original product warranty or 90 days, whichever is longer.

If the claimed nonconformity is warp of a door slab, we may defer repairing or replacing the door slab for a period up to twelve (12) months from the date of claim. It is not uncommon for a temporary warp condition to occur as the door slab adjusts to local humidity and temperature conditions. This deferral will not be counted against the warranty period.

What This Warranty Does NOT Cover

JELD-WEN is not liable for damage, product failure or poor product performance due to:

- Normal wear and tear, including normal wear and tear of weatherstrip; natural weathering of surfaces. Variance in color or texture of natural wood parts, and natural tarnishing of copper cladding are not considered defects.
- Normal wear and tear to hardware and naturally occurring changes to hardware finishes (e.g., corrosion or tarnishing).
- Exposure to chemicals (e.g. brick wash) or a harsh environment (e.g. salt spray or airborne pollutants) unless otherwise stated above.
- Misuse, abuse or failure to properly finish and provide maintenance.
- Alteration or modification to the Product (e.g. customer applied tints or films, paint finishes, security systems).
- Any cause beyond the reasonable control of JELD-WEN (e.g. fire, flood, earthquake, other acts of nature, and acts of third parties outside of our control).
- Failure to provide an adequate overhang for fiberglass doors; damage caused by extreme temperature buildup where storm doors are present. For general guidelines, see our "Appropriate Protection for Exterior Doors" in our product literature or at www.jeld-wen.com/resources; for specific information pertaining to your structure, consult your contractor or other building professional.

Continued on next page

- Improper installation not in conformance with JELD-WEN installation instructions (note: see www.jeld-wen.com for current installation instructions); operational problems and problems related to water and/or air infiltration/leaking as a result of improper installation or flaws in building design or construction.
- Installation into a condition that exceeds product design standards and/or certified performance specifications and/or is not in compliance with building codes.
- Extreme artificial temperature buildup or exposure (e.g., where storm doors/windows are present).
- Hardware or inserts that are not provided by us, such as locksets, door handles, strikes, etc.
- Condensation or damage as a result of condensation (Note: unless due to insulating glass failure, most condensation problems are related to excessive humidity levels in a structure. Contact a heating/air conditioning specialist for help).
- Wood decay in wood components other than of pine species and any components (including pine) that come in direct contact with soil. Note: superficial mold/mildew does not indicate wood decay.

JELD-WEN is also not liable for:

- Glass breakage (except as covered above).
- Screen damage due to normal wear and tear, misuse, abuse, or insect or animal activity.
- Slight expansion or contraction due to varying environmental conditions; slab movement (shrinkage or swelling) of 1/4" or less due to temperature and humidity, consult the Homeowner's Manual on how to work with this natural movement.
- Slight imperfections or wavy distortions in the glass that don't impair structural integrity. Note: wavy distortions in the glass (e.g. related to laminate interlayer or heat strengthening of glass) are not considered a defect. Slight color variations in glass are not considered a defect.
- Hairline cracks in factory-applied finishes; surface cracks that do not compromise the underlying material are not a defect.
- Damage or distortion to other property, including but not limited to, vinyl siding, building components or landscaping caused in whole or in part by reflection of light or heat from JELD-WEN windows or doors.
- Product or component performance decline due to aging, inert gas dissipation, natural processes or failure to provide proper maintenance. Note: Other than inert gas loss due to seal failure, the migration of an inert gas, such as argon, is a natural process that occurs over time and is not a defect.
- Repairs on product not accessible by road; travel costs related to repairs on product located more than 125 miles/200 kilometers from an authorized dealer; providing, assembling, or dismantling scaffolding, lifts, or other specialized equipment.
- Labor and materials for repainting or refinishing activities or the removal or disposal of defective product(s); labor exceeding the time periods specified above.
- Incidental or consequential damage. Some states/provinces do not allow the exclusion or limitation of incidental or consequential damages, so this may not apply to you.

Important Legal Information -- Please read this carefully. It affects your rights.

This Limited Warranty document sets forth our maximum liability for our products. We shall not be liable for special, indirect, consequential, or incidental damages. Your sole and exclusive remedy with respect to any and all losses or damages resulting from any cause whatsoever shall be as specified above. We make no other warranty or guarantee, either express or implied, including implied warranties of merchantability and fitness for a particular purpose to the original purchaser or to any subsequent user of the Product, except as expressly contained herein. In the event state or provincial law precludes exclusion or limitation of implied warranties, the duration of any such warranties shall be no longer than, and the time and manner of presenting any claim thereon shall be the same as, that provided in the express warranty stated herein. This Limited Warranty document gives you specific legal rights, and you may have other rights that vary from state/province to state/province.

Any dispute, controversy or claim arising out of or relating to this warranty, any alleged breach thereof, or the use or sale of the products to which this warranty applies shall be resolved by mandatory and binding arbitration administered by the American Arbitration Association in accordance with its commercial arbitration rules. Any ensuing arbitration will be venued in Charlotte, North Carolina. Original purchaser agrees that they may assert claims against JELD-WEN in their individual capacity only, and not as a plaintiff or class member in any purported class action proceeding. This warranty shall be interpreted in accordance with the laws of North Carolina (excluding North Carolina's conflict of laws principles). If any provision of this warranty is deemed illegal or unenforceable in a judicial proceeding, that provision shall be severed and excluded, and the remainder of this warranty shall continue in force. Rejection of these dispute resolution provisions must be sent to JELD-WEN at the address provided herein within thirty (30) days of original purchaser's receipt of the Products to which this warranty applies.

No distributor, dealer or representative of JELD-WEN has the authority to change, modify or expand this warranty. The original purchaser of this Product acknowledges that they have read this warranty, understand it and are bound by its terms and agrees to provide this warranty to the original owner of the structure into which the Product is installed.

¹ "JELD-WEN Products" shall refer to window and patio door products (except United Collection products) manufactured in the United States and/or Canada and marketed under the JELD-WEN brand name for use in the United States and/or Canada. See our separate United Collection warranty, or our Export Warranty for applicable coverage on products used outside the United States and Canada.

² "Skilled labor" refers to tasks where specialized technical knowledge, experience, methods or tools are required to properly identify, diagnose and/or correct product-related issues.

³ "Chalking" of the exterior finish is not a defect unless it exceeds a numerical rating of eight (8) when measured in accordance with the standard procedures specified in ASTM D4214. Fading or changing in color of the exterior finish is not a defect unless it exceeds five (5) E units, calculated in accordance with ASTM D2244, paragraph 6.2. Color change shall be measured on an exposed area of finish that has been cleaned of surface soils and chalk, and the corresponding values measured on the original or unexposed area of finish. Fading or color changes may not be uniform if the surfaces are not equally exposed to the sun and elements. If the above ASTM standards change, the standard in effect at the time of purchase applies. As an option to replacement, we may choose to refinish the product.



JELD WEN

© 2021 JELD-WEN, Inc. All rights reserved. | JELD-WEN, the JELD-WEN Logo, the JW Logo, AURALAST, and SITELINE are registered trademarks of JELD-WEN, Inc. BELMAR, HARLESTON, HYDROLOCK, and WHITBY are trademarks of JELD-WEN, Inc. ENERGY STAR is a registered trademark of the US Environmental Protection Agency. BLINK BLINDS + GLASS is a registered trademark of ODL, Inc. HOPPE is a registered trademark of HOPPE Holding AG.

11-96987 05/24